



THE RANGE

10kVA - 4376kVA

Engineering Excellence Built on Experience

With more than forty years of expertise in the design and manufacture of diesel generating sets our management team ensures every AJ Power generating set will provide reliable power and peace of mind.

Whether used daily or in an emergency, you can be assured our expert team has created a power solution with you and your needs in mind.

AJ Power headquarters are based at modern facilities in Northern Ireland, UK with subsidiary offices in Sweden and South Africa and regional offices in England and Dubai.

This network of offices enables us to continue to provide service and support to customers worldwide.

AJ Power generating sets are made in the UK at our headquarters and since the inception of the company in 2003.

All of our generators up to 7 Series are produced on powered automotive style assembly tracks by skilled operatives prior to load and functional testing in advanced test cells.

The largest machines are assembled in an ultra-modern high bay assembly plant with the most advanced testing facilities available for multiple units up to 4376kVA capacity (low or high voltage).

As the company continues to grow so do the services/ capabilities we offer to our customers.

AJ Power is proud of its origins and strives to continue to bring superior products, manufactured in the United Kingdom, to world markets.

Over 35,000 AJ Power generating sets have been designed, manufactured and distributed to over 85 countries worldwide.



1. Main office facilities at our factory in Northern Ireland. 2. State-of-the-art large machine test cells. 3. Large machine assembly facility. 4. Series 9 machine assembly. 5. Tandem Brake Press. 6. South Africa Offices 7. 43,000 sqft warehouse and large scale fabrication plant. 8. Large stock of engines and alternators are held on-site. 9. Powder Coating Booth & Curing Oven



AJ POWER FACILITIES & CAPABILITIES

AJ Power specialises in the volume manufacture and bespoke design of diesel generating sets from 10kVA to 4376kVA. Our highly qualified team has a global vision that drives the company forward combined with state-of-the-art facilities, this allows us to deliver solutions to meet your needs.

The quality of the product and service provided by AJ Power to its customers is the concern of each member of the organisation.

We believe quality is not a matter of chance, but develops from sound engineering processes and superior components. To assist the company in achieving its quality requirements it is committed to operating in a manner that sustains registration to the International Quality Standard ISO 9001:2015, ISO 14001:2015 and ISO 45001:2018. It is the Organisation's belief that, in operating to these standards, it will meet the requirements of its customers and the industry.

Services:

- Technical Site Surveys
- After Sales Support
- Product Training
- Project Management
- Manufacture of Acoustic Containers
- Factory or Site Witness Test
- Commissioning

Capabilities:

- Large Scale Fabrication
- Low / Medium / High Voltage
- Automated Production
- Container Design & Manufacture
- Choice of Engines & Alternators Brands
- 10kVA - 4376kVA
- Digital Control Systems
- Remote Communications
- Utility Synchronising



**ALL AJ POWER DIESEL
GENERATORS ARE MADE IN THE UK**



**RECYCLING SECTOR SOLUTION
AJ66 - PERKINS**

Choose your perfect generating set



3 SERIES

Power:
10kVA - 110kVA

Overview:

Our smallest range offering you desirable power in a compact package.

Sectors Served:

Telecommunications, Construction, Residential, Retail.



5 SERIES

Power:
33kVA - 275kVA

Overview:

Setting standards for others to follow. Offering a complete array of additional options.

Sectors Served:

Construction, Residential, Agriculture, Industrial, Commercial.



7 SERIES

Power:
275kVA - 938kVA

Overview:

A popular range including models to meet stringent emissions legislation.

Sectors Served:

Industrial, Construction, Mining, Commercial, Events, Utility.



9 SERIES

Power:
800kVA - 4376kVA

Overview:

Our largest generating set range, offering power you can depend on, when it counts.

Sectors Served:

Data Centres, Healthcare, Commercial, Industrial, Banking.



AJ POWER ENGINES AND ALTERNATORS



To ensure world-class quality our major components such as engines, alternators and steel are all produced or sourced in the United Kingdom, Europe, United States of America or Japan. Investment in class-leading technology and processes ensure that each AJ Power generating set meets and exceeds your expectations time after time.

We offer a range of engine choices and two alternator choices - Mecc Alte or Newage Stamford.

For over 60 years Cummins has provided durable and reliable power solutions to construction and industrial equipment across the globe.

Mitsubishi industrial engines have a worldwide reputation for reliability, fuel economy and long life.

Their long stroke and low compression design reduces engine stress. Service friendly design reduces maintenance costs and shortens machine downtime.

Mecc Alte are a world leading producer and supplier of synchronous alternators.

As a totally independent company they are focused fully on producing world class alternators.



AJ POWER ENGINES AND ALTERNATORS



For over 80 years Perkins have worked with generator set manufacturers to bring light, warmth, protection and of course peace of mind to thousands of people.

Manufactured in Europe and have nearly 100 years experience in building electrical machines, widely known throughout the world of power generation for reliability.

The demand for prime power and standby power generation is constantly growing.

In either case - wherever there is a critical need for dependable, class-leading fuel efficient workhorses that require a minimum of service and maintenance - the answer is Scania engines for power generation.





AJ POWER CANOPIES FEATURES

AJ Power's weather protective and sound attenuated enclosures deliver durability and security for your generating set. Manufactured from pretreated galvanised steel and coated with highly durable polyester powder paint, the canopies are designed with low velocity airflow to minimise the ingress of water, sand and dust.

A range of options are available to tailor your generating set to meet your needs, including optional canopy offering low noise level - perfect for urban locations. The ingress of water, sand and dust this is extremely advantageous to the operational life of the engine and alternator and will ensure your AJ Power sound attenuated generating set will operate in even the harshest conditions.

High Specifications:

- Maximised service access
- Digital control system
- High ambient cooling capabilities
- Extensive range of options
- They are designed to minimise noise and maximise ambient clearance with air
- Gas spring assisted side doors (3 Series)
- Galvanised canopies
- Our sound attenuated enclosures are fabricated from 1.5/2.0mm hot dipped galvanised steel and pre-treated before powder coated using polyester powder to a thickness between 60-100µm.
- They are designed to minimise noise and maximise ambient clearance with air velocity below 2.5m/s.
- This minimises the risk of dust and moisture ingress.



NOISE ABSORBENT MATERIALS

Enclosure is fully lined with noise absorbent material, as standard, to ensure low noise levels.

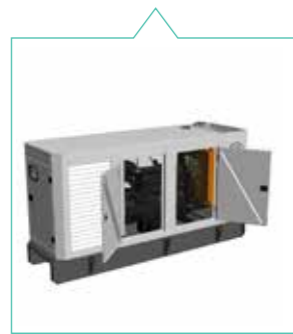

SERVICING MADE EASY

Large hinged doors provide access to all necessary components during installation and servicing. Lift-off hinges also available.



CONVENIENT CABLE ACCESS

Large aperture cable gland plate positioned below circuit breaker for ease of cable installation.



SINGLE POINT LIFT FRAME

Eye hook fitted to the top centre of canopy provides a means of lifting genset and is useful during installation.



AJ POWER CANOPIES FEATURES

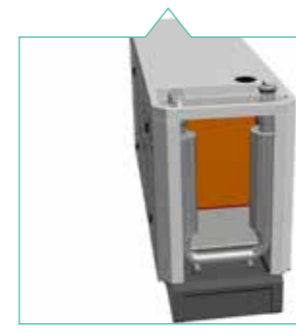

INTERNAL EXHAUST SILENCER SYSTEM

The exhaust silencer system is safely enclosed in the outlet of the enclosure.

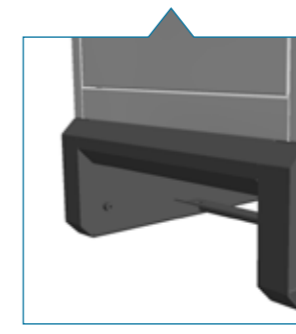

INNOVATIVE DESIGN

Design decisions are evaluated at each stage to ensure a machine has low noise levels, high ambient clearance, low intake velocity whilst having a compact modern style.

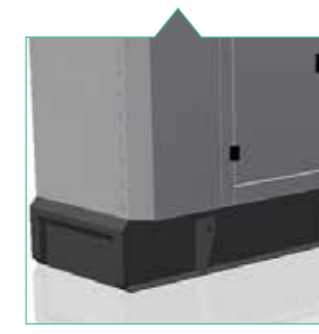

CORROSION & DAMAGE RESISTANT

Fully galvanised steel enclosure coated in highly durable polyester powder paint.

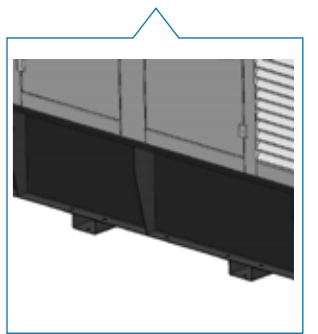

FORK POCKETS

An opening in the base frame for insertion of the prongs of a forklift.



AJ POWER ACOUSTIC ENCLOSURES

Bespoke containers for the entire range of AJ Power generating sets are available. We work with your specifications and deliver a unique product.

Containerised generators are available in: 10ft, 20ft and 40ft.

These are perfect for the most demanding usage and are designed to your project specification and requirements.

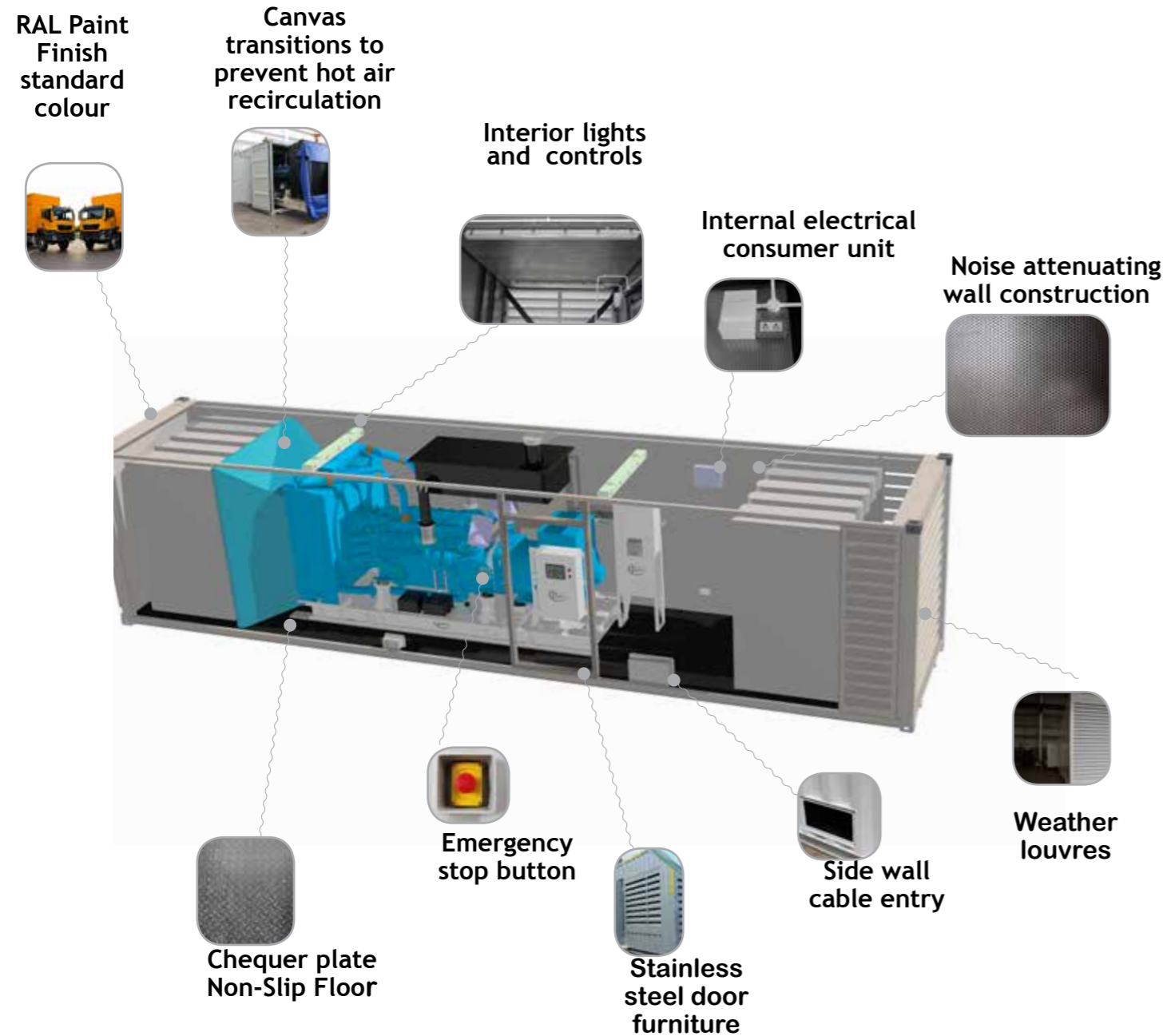

AJ POWER ACOUSTIC ENCLOSURES

We also offer you a range of options and features should you require something more bespoke.

Optional Features

- Motor operated air inlet / outlet louvres
- CSC plated for ease of transport (top stack only)
- Bunded enclosure floor with leak detection sump/alarm
- Radiator fill pump
- Bulk fuel tank and engine drain connections piped to side wall
- Internal thermostatically controlled heating
- RAL colour options available
- External cable link box
- Fully assembled Factory Witness Test
- Internal fuel tank and connections
- CE Labelling of genset / container package
- Automatic fire detection and suppression system
- Fuel line fire valve / fusible link protection
- Automatic engine oil top up system
- Air inlet / outlet snow cowls
- Silencer finish in hot aluminium metal spray
- Floor cable exit



3 Series - 10kVA - 110kVA

The attention to detail and high standards of engineering can be seen immediately in the AJ Power 3 Series.

OVERVIEW

The smallest range from AJ Power, the 3 Series, offers reliable power in an ultra compact solution.

A range of options are available to tailor your generating set to meet your needs, including optional canopy offering low noise level - perfect for urban locations.

STANDARD FEATURES

- Emergency Stop Push Button
- Battery
- InSight3100 Control Panel
- Base Tank
- Fuel Tank Level Gauge
- IP23 Protection
- Standard Coolant Solution
- Radio Frequency Interference Suppression Kit (RFi)

3 Series - 10kVA - 110kVA

SECTORS SERVED INCLUDE:

Telecommunications - Construction - Residential - Retail

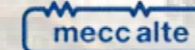
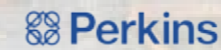

3 Phase

Model	50Hz				60Hz			
	Prime		Standby		Prime		Standby	
	kVA	kW	kVA	kW	kVA	kW	kVA	kW
AJ10	9.0	7.2	10.0	8.0	11.3	9.0	12.5	10.0
AJ14	13.0	10.4	14.3	11.4	15.6	12.5	17.4	13.9
AJ17	15.0	12.0	16.5	13.2	-	-	-	-
AJ22	20.0	16.0	22.0	17.6	22.5	18.0	25.0	20.0
AJ33	30.0	24.0	33.0	26.4	33.8	27.0	37.5	30.0
AJ50	45.0	36.0	50.0	40.0	56.3	45.0	62.5	50.0
AJ66	60.0	48.0	66.0	52.8	70.0	56.0	77.5	62.0
AJ88	80.0	36.0	88.0	40.0	95.0	76.0	105.0	84.0
AJ110	100.0	48.0	110.0	52.8	118.8	95.0	131.3	105.0



Single Phase

Model	50Hz				60Hz			
	Prime		Standby		Prime		Standby	
	kVA	kW	kVA	kW	kVA	kW	kVA	kW
AJ10	8.3	6.6	9.1	7.3	10.4	8.3	11.5	9.2
AJ14	11.9	9.5	13.1	10.5	14.6	11.7	16.3	13.0
AJ17	13.1	10.5	14.3	11.4	-	-	-	-
AJ22	18.9	15.1	20.7	16.6	22.5	18.0	25.0	20.0
AJ33	28.1	22.5	31.1	25.0	33.8	27.0	37.5	30.0
AJ50	43.8	35.0	47.5	38.0	-	-	-	-
AJ66	56.2	45.0	62.5	50.0	-	-	-	-



Ratings based on 3ph, 400/230 Volt, 0.8pf, 50 Hz and 3 ph, 480/277 Volt, 0.8pf, 60 Hz, 1 phase 220/110 Volt 0.8pf, Refer to factory for further information.

5 Series - 33kVA - 275kVA

The 5 Series range from AJ Power is setting the standards for others to follow.

OVERVIEW

The 5 Series from AJ Power delivers exceptional performance, reliability, durability and low operating costs.

The 5 Series offers excellent fuel consumption and is well equipped to deal with even the most arduous of conditions.

STANDARD FEATURES

- Emergency Stop Push Button
- Battery
- InSight3100 Control Panel
- Base Tank
- Fuel Tank Level Gauge
- IP23 Protection
- Standard Coolant Solution
- Radio Frequency Interference Suppression Kit (RFi)

5 Series - 33kVA - 275kVA

SECTORS SERVED INCLUDE:

Construction - Residential - Agricultural - Industrial - Commercial

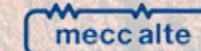
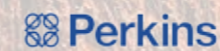

NEWAGE | STAMFORD | AvK

Fuel Optimised

Model	50Hz				60Hz			
	Prime		Standby		Prime		Standby	
	kVA	kW	kVA	kW	kVA	kW	kVA	kW
AJ33	30.0	24.0	33.0	26.4	33.8	27.0	37.5	30.0
AJ50	45.0	36.0	50.0	40.0	56.3	45.0	62.5	50.0
AJ66	60.0	48.0	66.0	52.8	70.0	56.0	77.5	62.0
AJ88	80.0	64.0	88.0	70.4	95.0	76.0	105.0	84.0
AJ110	100.0	80.0	110.0	88.0	118.8	95.0	131.3	105.0
AJ150	135.0	108.0	150.0	120.0	--	--	--	--
AJ165	150.00	120.0	165.0	132.0	168.6	135.0	187.5	150.0
AJ200	180.0	144.0	200.0	160.0	200.0	160.0	218.8	175.0
AJ220	200.0	160.0	220.0	176.0	203.8	163.0	225.0	180.0
AJ250	230.0	160.0	250.0	176.0	230.0	184.0	250.0	200.0
AJ275	250.0	200.0	275.0	220.0	243.6	195.0	268.6	215.0

Ratings based on 3ph, 400/230 Volt, 0.8pf, 50 Hz and 3 ph, 480/277 Volt, 0.8pf, 60 Hz, 1 phase 220/110 Volt 0.8pf, Refer to factory for further information.

Single Phase

Model	50Hz				60Hz			
	Prime		Standby		Prime		Standby	
	kVA	kW	kVA	kW	kVA	kW	kVA	kW
AJ33	28.1	22.5	31.3	25.0	33.8	27.0	37.5	30.0
AJ50	43.8	35.0	47.5	38.0	52.5	42.0	57.5	46.0
AJ66	53.3	45.0	62.5	50.0	66.3	53.0	72.9	58.3



5 Series Project Overview:

Sector:
Commercial

Genset:
AJ275

Services:
Design and Install



7 Series - 275kVA - 938kVA

Building the best generating sets in the world is our aim and the 7 Series speaks louder than words.

OVERVIEW

Ready to meet the demands of your industry, the 7 Series boasts an array of standard features plus a complete range of additional options.

These engines offer high performance cooling systems, high uptime, low operational costs and long service intervals - delivering power you can depend on.

STANDARD FEATURES

- Emergency Stop Push Button
- Battery
- InSight3100 Control Panel
- Base Tank
- Fuel Tank Level Gauge
- IP23 Protection
- Standard Coolant Solution
- Radio Frequency Interference Suppression Kit (RFi)
- Electronic Governor

7 Series - 275kVA - 938kVA

SECTORS SERVED INCLUDE:

Industrial - Construction - Mining - Commercial - Events - Utility

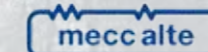

Fuel Optimised

Model	50Hz				60Hz			
	Prime		Standby		Prime		Standby	
	kVA	kW	kVA	kW	kVA	kW	kVA	kW
AJ275	250.0	200.0	275.0	220.0	281.3	225.0	312.5	250.0
AJ280	250.0	200.0	280.0	224.0	281.3	225.0	312.5	250.0
AJ300	275.0	220.0	300.0	240.0	312.5	250.0	343.8	275.0
AJ310	280.0	224.0	310.0	248.0	306.3	245.0	343.8	275.0
AJ330	300.0	240.0	330.0	264.0	337.5	270.0	375.0	300.0
AJ360	330.0	264.0	360.0	288.0	362.5	290.0	412.5	330.0
AJ375	350.0	280.0	375.0	300.0	387.5	310.0	437.5	350.0
AJ385	350.0	280.0	385.0	481.3	--	--	--	--
AJ400	350.0	280.0	400.0	320.0	412.5	330.0	462.5	370.0
AJ440	400.0	320.0	440.0	352.0	431.3	345.0	500.0	400.0
AJ450	400.0	320.0	450.0	360.0	--	--	--	--
AJ460	410.0	328.0	460.0	368.0	450.0	360.0	512.5	410.0
AJ500	450.0	360.0	500.0	400.0	500.0	400.0	556.3	445.0
AJ550	500.0	400.0	550.0	440.0	591.3	473.0	646.3	517.0
AJ615	560.0	448.0	615.0	492.0	550.0	440.0	606.3	485.0
AJ660	600.0	750.0	660.0	528.0	650.0	520.0	712.5	570.0
AJ670	610.0	488.0	670.0	536.0	607.5	487.0	671.3	537.0
AJ710	650.0	520.0	710.0	568.0	660.0	520.0	728.8	570.0

Fuel Optimised

Model	50Hz				60Hz			
	Prime		Standby		Prime		Standby	
	kVA	kW	kVA	kW	kVA	kW	kVA	kW
AJ779	700.0	560.0	770.0	616.0	700.0	560.0	770.0	616.0
AJ779	--	--	--	--	711.3	569.0	778.0	623.0
AJ780	707.0	565.6	780.0	624.0	--	--	--	--
AJ850	750.0	600.0	825.0	660.0	800.0	640.0	890.0	712.0
AJ895	--	--	--	--	813.0	650.4	895.0	716.0
AJ938	--	--	--	--	850.0	680.0	937.5	750.0

Ratings based on 3ph, 400/230 Volt, 0.8pf, 50 Hz and 3 ph, 480/277 Volt, 0.8pf, 60 Hz, 1 phase 220/110 Volt 0.8pf, Refer to factory for further information.



9 Series - 800kVA - 4376kVA

Years of expertise are poured into every 9 Series generating set to deliver power solutions you can rely on.

OVERVIEW

The 9 Series is the largest power range from AJ Power. Whether it be low or high voltage (3.3-13.8kV), our engineer's can come up with a solution.

A wide range of technical additional options are available on these generating sets to ensure the ultimate solution.

STANDARD FEATURES

- Emergency Stop Push Button
- Battery
- InSight3300 Control Panel
- IP23 Protection
- Standard Coolant Solution
- Radio Frequency Interference Suppression Kit (RFi)
- Electronic Governor
- Coolant Drain
- Lube Oil Drain

9 Series - 800kVA - 4376kVA

SECTORS SERVED INCLUDE:

Data Centres - Healthcare - Commercial - Industrial - Banking

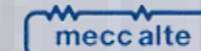

NEWAGE | STAMFORD | AvK

Fuel Optimised

Model	50Hz				Model	60Hz			
	Prime		Standby			Prime		Standby	
	kVA	kW	kVA	kW		kVA	kW	kVA	kW
AJ800	730.0	584.0	800.0	640.0	--	--	--	--	--
AJ880	800.0	640.0	880.0	704.0	--	--	--	--	--
AJ900	800.0	640.0	900.0	720.0	AJ900	908.8	727.0	1000.0	800.0
AJ1000	910.0	728.0	1000.0	800.0	AJ1000	1028.8	823.0	1125.0	900.0
AJ1100	1000.0	800.0	1100.0	880.0	--	--	--	--	--
AJ1250	1125.0	900.0	1250.0	1000.0	AJ1250	1138.0	910.4	1250.0	1000.0
AJ1400	1275.0	1020.0	1400.0	1120.0	AJ1400	1378.7	1103.0	1533.7	1227.0
AJ1500	1350.0	1080.0	1500.0	1200.0	--	--	--	--	--
AJ1540	1400.0	1120.0	1540.0	1232.0	AJ1540	1560.0	1248.0	1715.0	1372.0
AJ1650	1500.0	1200.0	1650.0	1320.0	AJ1650	1737.5	1390.0	1912.5	1530.0
AJ1770	1650.0	1320.0	1770.0	1416.0	--	--	--	--	--
AJ1875	--	--	--	--	AJ1875	1600.0	1280.0	1875.0	1500.0
AJ1900	1725.0	1380.0	1900.0	1520.0	AJ1900	1868.7	1495.0	1683.7	1347.0
AJ2000	1800.0	2250.0	2000.0	1600.0	--	--	--	--	--
AJ2090	1915.0	1532.0	2090.0	1672.0	AJ2090	2062.5	1650.0	2268.7	1815.0
AJ2188	--	--	--	--	AJ2188	2119.0	1695.2	2263.0	1810.4
AJ2250	2000.0	1600.0	2250.0	1800.0	--	--	--	--	--
AJ2260	2020.0	1616.0	2260.0	1808.0	AJ2260	1737.5	1800.0	2500.0	2000.0

Fuel Optimised

Model	50Hz				Model	60Hz			
	Prime		Standby			Prime		Standby	
	kVA	kW	kVA	kW		kVA	kW	kVA	kW
AJ2500	2260.0	1808.0	2500.0	2000.0	AJ2500	2281.0	1824.8	2500.0	2000.0
AJ2530	2300.0	1840.0	2530.0	2024.0	--	--	--	--	--
AJ2680	2500.0	2000.0	2680.0	2144.0	--	--	--	--	--
AJ2700	2420.0	1936.0	2670.0	2136.0	--	--	--	--	--
AJ2750	2500.0	2000.0	2750.0	2200.0	--	--	--	--	--
AJ2800	2545.0	2036.0	2800.0	2240.0	--	--	--	--	--
AJ3000	2750.0	3437.5	3000.0	3750.0	--	--	--	--	--
AJ3350	3050.0	3812.5	3350.0	4187.5	--	--	--	--	--
AJ3750	3350.0	4187.5	3750.0	4687.5	--	--	--	--	--
AJ3120	--	--	--	--	AJ3120	3873.8	2275.0	3120.0	2496.0
AJ3438	--	--	--	--	AJ3438	3125.0	2500.0	3438.0	2750.4
AJ4000	--	--	--	--	AJ4000	3660.0	2928.0	4025.0	3220.0
AJ4376	--	--	--	--	AJ4376	3750.0	3000.0	4376.0	3500.8

Ratings based on 3ph, 400/230 Volt, 0.8pf, 50 Hz and 3 ph, 480/277 Volt, 0.8pf, 60 Hz, 1 phase 220/110 Volt 0.8pf, Refer to factory for further information.

Digital Control Systems

Operation made easy using the most up-to-date control systems. AJ Power can provide a control system to meet all your needs.

The modern range of digital control systems offers flexibility for the user, ease of use and optimises the performance of your generating set.



InSight3100 - The InSight3100 is a microcontroller based generator control unit that is used to start and stop the genset manually or via a remote start signal when in automatic mode. The device is designed to run and monitor system parameters to ensure fail-safe genset operation.



InSight3300 - The InSight 3300 is an Advanced single Gen-set, Auto Start controller for stand-by and prime-power applications. All-in one intuitive & powerful PC tool for configuration/ monitoring/ control, locally or remotely.



InSight4100 - The InSight 4100 is an advanced single Gen-set controller for AMF (Automatic Mains Failure) applications. This includes automatic Genset start on a mains failure detection and 'open transition' breaker control. All-in-one intuitive & powerful PC tool for configuration/ monitoring/control, locally or remotely.



InSight5200 - A comprehensive paralleling generator set controller capable of managing up to 32 generator sets. Direct communication is via the Engine Control Unit and the controller also offer the ability to monitor your generator set remotely.



InSight6000s- Combines all of the powerful original features of the previous generation InSight6000 with added functionality, new front fascia layout and hardware enhancements. The InSight 6000s range can offer a solution for various synchronising applications from AMF, peak shaving and import/export control.



Remote Communications Solutions - Remote communications options are available with all AJ Power digital control systems. Remote communication can give many advantages including reducing the need for site visits, minimising downtime, prioritising maintenance and alarm notification.

Automatic Transfer Switch

Operation made easy using the most up-to-date control systems. AJ Power can provide a control system to meet all your needs.

The modern range of digital control systems offers flexibility for the user, ease of use and optimises the performance of your generating set.



ATS2 - AJ Power's range of advanced automatic transfer panels offers automatic control of standby generating sets. The ATS2 panels are available from 40A - 4000A ratings and include a digital ATSc controller with '2 wire' control interface to the generator control panel. All intelligence is within the ATS2 controller.



ATS 3 - AJ Power Automatic Transfer Switch (ATS3) is designed to continually monitor the mains (Grid) AC power supply for under / over voltage and under / over frequency for both single and three phase systems. If a mains (Grid) AC failure is detected, a start request is issued to the generator. Available from 100 - 630amps.



5MW BACKUP SOLUTION
10 X AJ770 SCANIA

Global Network

AJ POWER WORLDWIDE DISTRIBUTION NETWORK

- Over 30000 gensets worldwide
- Established 2003
- All gensets manufactured in the UK
- Choice of engines & alternators brands
- Fully validated in the UK
- 85 countries worldwide
- Network of global distributors
- Offices in N. Ireland, England, Sweden, Dubai, South Africa
- 10kVA- 4376kVA



Diesel Generators Worldwide

AJ Power and our extensive network of distributors are committed to finding the right product for you and then supporting you with the best service, parts, training and commissioning, when you need it. We are always ready to go the extra mile to support your purchase.

We can offer tailored generating set training courses from basic to advanced level. These are available on location or at the modern AJ Power training suite at the factory in Northern Ireland.

One of the key criteria for all our customers is the availability of parts. We recognise this and invest resources in making sure the correct parts are available in the quickest time.

We also spend time training our distributors and their engineers to ensure they fully understand your parts requirements. We are committed to keeping your machines running.





AJ POWER SPECIFICATIONS

- Standard
- Optional
- RTF Not available/ Not applicable Refer to Factory

Our range of generating sets are packed with standard features including robust base frame, low lube oil pressure shutdown, over speed protection, high coolant temperature shutdown, low battery voltage alarm, battery charging system failure, industrial silencer (optional extra on 9 Series), 3 pole suitably rated circuit breaker (optional extra on 9 Series), fuel tank level gauge, emergency stop push button, base fuel tank (not applicable to 9 Series). Also available is a complete array of optional extras to ensure your AJ Power generating sets meet your needs entirely.

	3 Series	5 Series	7 Series	9 Series
Control System				
InSight3100	●	●	●	-
InSight3300 (Not on 3S AJ88/AJ110)	○	○	○	●
InSight4100 (Not on 3S AJ88/AJ110)	○	○	○	○
InSight5200 (Not on 3S AJ88/AJ110)	○	○	○	○
InSight6000S	-	○	○	○
Control panel heater	-	○	○	○
G59 / G10 main protection relay	-	RTF	RTF	RTF
Remote display panel (3300/4100/5200/6000s)	○	○	○	○
Protection alarms (various)	○	○	○	○
Automatic load transfer panels				
ATS (40 Amp - 6300 Amp)	○	○	○	○
Sound attenuated enclosure	○	○	○	N/A
Engine				
Electronic governor	-	○	●	●
Coolant drain	-	-	●	●
Coolant heater	○	○	○	○
Lube oil drain (standard on canopied sets)	○	○	●	●
Lube oil drain pump	○	○	○	○
Approaching low lube oil pressure alarm	○	○	○	-
High lube oil temperature shutdown	-	-	-	○
Alternator				
Anti- condensation heater	○	○	○	○
Permanent magnet generator (PMG)	○	○	○	○
Programming interface kit	○	○	○	○
Radio frequency interference suppression kit (RFI)	●	●	●	●
Upgrade AVR from 1-phase to 3-phase sensing	-	○	○	○
Total plus winding protection	○	○	○	○
IP23 protection	●	●	●	●
Radiator				
Transition mounting flange (open sets only)	○	○	○	○
Standard coolant solution (30% antifreeze)	●	●	●	●
Low ambient coolant solution (50% antifreeze)	○	○	○	○
Low coolant temperature alarm Added back in PL	○	○	○	○
Approaching high coolant temperature alarm	○	○	○	○
Low coolant level alarm	○	○	○	○

Please Note: Some options dependant on open/ canopied generating set and are model dependant.



AJ POWER SPECIFICATIONS

- Standard
- Optional
- RTF Not available/ Not applicable Refer to Factory

	3 Series	5 Series	7 Series	9 Series
Baseframe / Handling				
Bunded fuel base tank	○	○	□	RTF
Bunded base tank with leak detection	-	○	○	RTF
Integral single skinned tank (600, 1000, 1300 litres - canopied sets only)	○	-	-	-
Extended bunded metal base tank	-	○	-	-
Single point lift (canopied sets only)	○	○	○	-
Captive anti-vibration mounts (required for trailer sets)	○	○	○	-
Fuel				
Base tank	● (100 litres)	●	●	RTF
Fuel tank level gauge	●	●	●	RTF
Fire valve kit	-	○	○	RTF
Low fuel level shutdown	○	○	○	RTF
Low fuel level alarm	○	○	○	RTF
Analogue fuel level measurement	○	○	○	RTF
4 Position fuel level switch	○	○	○	RTF
3 Way dual valve with single lever operation	○	○	○	RTF
Manual fuel transfer pump & hose	○	○	○	RTF
Automatic fuel transfer system	○	○	○	RTF
Exhaust				
Industrial silencer mounting kit	○	○	○	○
Residential silencer (loose) standard on canopy sets	○	○	○	○
Residential silencer mounting kit	○	○	○	○
Stainless steel bellows (standard on canopy sets)	○	○	○	○
AC Power Out (3 Phase)				
Upgrade to 4 pole circuit breaker	○	○	○	○
Auxiliary contact in circuit breaker	○	○	○	○
16A/32A/63A CEE Form Socket - 50Hz only	○	○	RTF	-
Motorised kit for circuit breaker	-	□	□	□
Earth leakage protection for main circuit breaker	○	○	○	○
Battery				
Battery isolator switch	○	○	○	○
Static battery charger incl. BC failure	○	○	○	○
Static battery charger incl. BC failure & boost	○	○	○	○
Other Accessories				
Sound attenuated container	○	○	○	○
Tool kit	○	○	○	○
Packing case (open set)	○	○	○	○
UKNI / CE certification	○	○	○	○
Additional operators manual	○	○	○	○

Please Note: Some options dependant on open/ canopied generating set and are model dependant.



GENSET CONTROLLER FEATURES



Application	Insight 3100	Insight 3300	Insight 4100	Insight 5200	Insight 6000s	Insight 6400s
Single unit	✓	✓	✓	✓	✓	✓
Standby	✓	✓	✓	✓	✓	✓
Remote start (2 wire)	✓	✓	✓	✓	✓	✓
Automatic mains failure	-	-	✓	✓	✓	✓
Multiple unit paralleling / Mains paralleling	-	-	-	✓	✓	✓
Display media						
Digital display of measured parameters	✓	✓	✓	✓	✓	✓
LCD graphical display	✓	✓	✓	✓	✓	✓
Genset parameter display						
AC voltage x 6 (V12, V23, V31, V1N, V2N, V3N)	✓	✓	✓	✓	✓	✓*
AC current (L1, L2, L3)	✓	✓	✓	✓	✓	✓
Frequency (Hz)	✓	✓	✓	✓	✓	✓
Operation hours	✓	✓	✓	✓	✓	✓
Battery voltage	✓	✓	✓	✓	✓	✓
Engine coolant temperature	✓	✓	✓	✓	✓	✓
Engine lube oil pressure	✓	✓	✓	✓	✓	✓
Start attempts	✓	✓	✓	✓	✓	✓
Tachometer	✓	✓	✓	✓	✓	✓
Power kVA/kVAr	✓	✓	✓	✓	✓	✓
Power kW	✓	✓	✓	✓	✓	✓
Power factor	✓	✓	✓	✓	✓	✓
Energy kWh/kVAh/kVAh	✓	✓**	✓**	✓**	✓**	✓**
Mains parameter display						
AC voltage x6 (V12, V23, V31, V1N, V2N, V3N)	-	-	✓	✓	✓	✓
AC current x 1 (L1)	-	-	-	✓	✓	✓
Frequency	-	-	✓	✓	✓	✓
Power (kW, kVA, kVar)	-	-	-	-	-	-
Measuring						
Mains or ground current (1 x true r.m.s; mains or ground current selectable)	-	-	-	✓	✓	✓
Mains/Busbar voltage (3-phase/4 wire)	-	-	-	✓	✓***	✓***
Operator controls						
Configuration via front panel	✓	✓	✓	✓	✓	✓
Emergency stop lockdown push button	✓	✓	✓	✓	✓	✓
Multilevel access via passwords	-	✓	✓	✓	✓	✓
Configuration via PC	✓	✓	✓	✓	✓	✓
Soft keys (with functions that depend on application and operation)	-	✓	✓	✓	✓	✓



GENSET CONTROLLER FEATURES



System control functions	Insight 3100	Insight 3300	Insight 4100	Insight 5200	Insight 6000s	Insight 6400s
Manual genset starting	✓	✓	✓	✓	✓	✓
Remote genset starting	✓	✓	✓	✓	✓	✓
Start logic for engine (crank, rest and no. of cycles)	✓	✓	✓	✓	✓	✓
Stop logic for engine (run on / cool down sequence)	✓	✓	✓	✓	✓	✓
Auto on / off control of heaters if fitted	✓	✓	✓	✓	✓	✓
Automatic genset starting under mains failure condition	✓	✓	✓	✓	✓	✓
Communications						
Can interface / J1939	✓	✓	✓	✓	✓	✓
Ethernet	-	-*1	-*1	-**1	✓	✓
RS485 Modbus	-	✓	✓	✓	✓	✓
USB	✓	✓	✓	✓	✓	✓
RS232	-	-*2	-*2	-*2	-	-
Protection						
Oil pressure	✓	✓	✓	✓	✓	✓
Coolant temperature	✓	✓	✓	✓	✓	✓
Fail to start	✓	✓	✓	✓	✓	✓
Emergency stop	✓	✓	✓	✓	✓	✓
Battery voltage over/under	✓	✓	✓	✓	✓	✓
Maintenance call	✓	✓	✓	✓	✓	✓
Generator: over / under voltage	✓	✓	✓	✓	✓	✓
Generator: over / under frequency	✓	✓	✓	✓	✓	✓
Generator: overload (kW)	✓	✓	✓	✓	✓	✓
Generator: reverse / reduced power	-	✓	✓	✓	✓	✓
Generator: unbalanced load	-	✓	✓	✓	✓	✓
Generator: instantaneous overcurrent	✓	✓	✓	✓	✓	✓
Generator: time-overcurrent (IEC 255 compliant)	✓	✓	✓	✓	✓	✓
Generator: IDMT-overcurrent	-	✓	✓	✓	✓	✓
Generator: ground fault (measure ground current)	-	-*3	-*3	✓	✓	✓
Generator: rotation field	-	✓	✓	✓	✓	✓
Generator: Pole slip	-	-	-	-	✓	✓
Engine: over / under speed	✓	✓	✓	✓	✓	✓
Engine: speed / frequency mismatch	-	-	-	-	✓	✓
Engine: cylinder temperature	-	-	-	-	✓	✓
Engine: D+ auxiliary excitation failure	✓	✓	✓	✓	✓	✓
Mains: voltage / frequency	-	-	✓	✓	✓	✓
Mains: phase shift / rotation field / ROCOF (df/dt)	-	-	-	✓	✓	✓
ECU Alarms / diagnostic fault codes	✓	✓	✓	✓	✓	✓



GENSET CONTROLLER FEATURES



Controls						
Breaker control logic (open transition)	2	1	2	2	2	3*
Mains parallel and multi-unit operation (up to 32 units)	-	-	-	✓	✓	✓
GCB and MCB synchronization	-	-	-	✓	✓	✓
Generator Group Breaker Control (GCB)	-	-	-	-	-	✓
Run-up Synchronization	-	-	-	-	-	✓
Import / export control / base load (kW and kVAR)	-	-	-	✓	✓	✓
Load-dependent start / stop	-	-	-	✓	✓	✓
n/f, V, P, Q and PF remote control via analogue input or interface	-	-	-	✓	✓	✓
Load / var sharing for up to 32 gensets	-	-	-	✓	✓	✓
Freely configurable PID controllers	-	-	-	-	3	3
I/Os						
Discrete inputs	4	8	8	8	12	12
Discrete outputs	6	8	8	8	12	12
Display and evaluation of J1939 analog values "supported SPNs" / ECO support	✓	✓	✓	✓	✓	✓
External discrete inputs / outputs	-	16/16 ^{#1}	16/16 ^{#1}	16/16 ^{#1}	32/32 ^{#1}	32/32 ^{#1}
Magnetic pickup	-	✓	✓	✓	✓	✓
Analog inputs	3	4	4	4	3	3
Analog outputs	-	-	-	2	2	2
External analog inputs / outputs	-	12/1 ^{#1}	12/1 ^{#1}	12/1 ^{#1}	16/4 ^{#1}	16/4 ^{#1}
Additional data						
Event recorder entries	50	350	350	350	1000	1000
Real time clock	-	✓	✓	✓	✓	✓
Internal PLC logics manager	-	✓	✓	✓	✓	✓
Expansion card available	-	✓*	✓*	✓*	✓	✓
Remote communication options	-	✓*2	✓*2	✓**	✓***	✓***
Remote display options	-	✓	✓	✓	✓	✓
LS5 support	-	-	-	-	-	✓

Note* Current and voltage designations are for 3-phase, 4-wire star configuration

* - 690V Available, ** - kWh not Available, *** - 2 Phase Bus Sensing, #1 - Available with CM3-Ethernet plug-in extension module, **1 - Available with CM-Ethernet plug-in extension module #2 - Available with CM-RS232-485 plug-in extension module

#3 - Available with CM-RS232-485 plug-in extension module, * - Includes GGB control, #1 - External modules required, * - 2 of Plug in modules and CAN modules available, #2 - Available with CM2-4G-GPS or CM3-Ethernet plug-in extension module, ** - Available with CM-4G-GPS or CM-Ethernet plug-in extension module, *** - Netbeiter required



HARLAND & WOLFF
AJ33 - N. IRELAND



AFTERSALES SUPPORT

AJ Power and our extensive network of distributors are committed to finding the right product for you and then supporting you with the best service, parts, training and commissioning, when you need it!

We spend time training our distributors and their engineers to ensure they fully understand your parts requirements. We are always ready to go the extra mile to support your purchase.



Parts

We are committed to keeping your machines running. We invest resources in making sure the correct parts are available in the quickest time. As well as supplying parts for all AJ Power products, we can also supply parts for non AJ Power products.

Fuel

AJ Power can advise on fuel storage/transfer and conditioning throughout the life of the genset. The incoming Government changes to the use of rebated diesel in the Generator Market has raised the profile of fuel management in standby and Prime applications.

Servicing

We provide maintenance contracts and servicing on AJ Power generating sets and non AJ Power product.

Commissioning

Commissioning services are offered on AJ Power generating sets and associated switchgear.

Installations

AJ Power do offer genset installation advice and recommended contractors where required, this can range from the basic installation of a residential canopied set to Multiple sets installation in an industrial application, included switchgear, bulk fuel storage/transfer and flue systems.

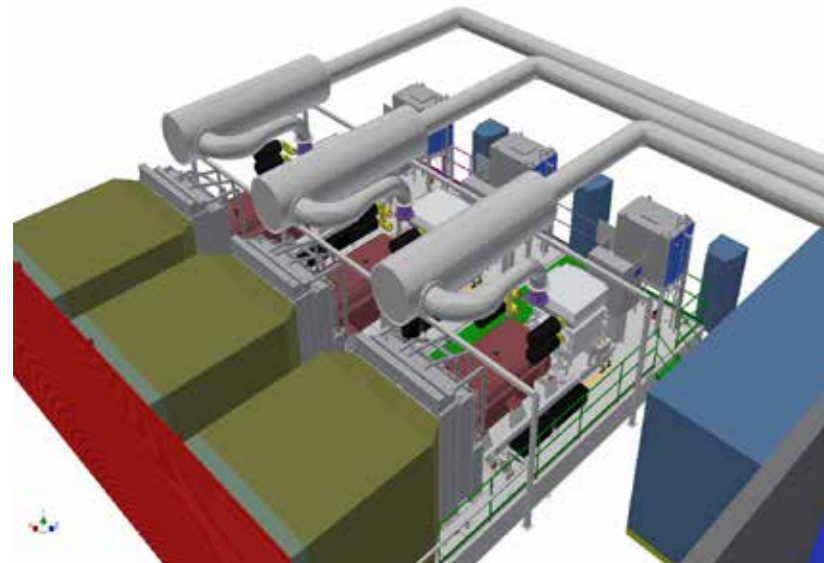

AFTERSALES SUPPORT

Maintenance Contracts

AJ Power do offer maintenance contracts on their product locally and further afield through certified agents, these contracts vary from simple servicing at manufacturer's intervals to load testing/ synching with the utility with fluid sampling and remote monitoring/control.

Training

We can offer tailored generating set training courses from basic to advanced level, including synchronising systems and remote monitoring and control. Training is available on location or at the modern AJ Power training suite at the factory in Northern Ireland.



QUALITY ASSURED

The quality of the product and service provided by AJ Power to its customers is the concern of each member of the organisation.

We believe quality is not a matter of chance, but develops from sound engineering processes and superior components.

To assist the company in achieving its quality requirements it is committed to operating in a manner that sustains registration to the International Quality Standard ISO 9001, ISO 45001 and ISO 18001 along with CE and UK NI.



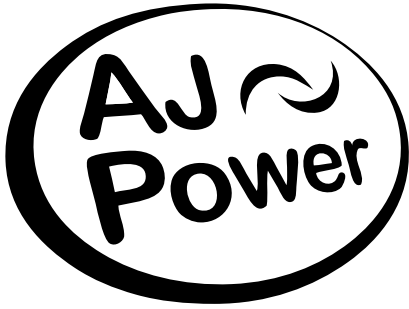

Diesel generating sets worldwide

HEAD QUARTERS

AJ Power Limited
1 Charlestown Drive
Craigavon
BT63 5GA
Northern Ireland
United Kingdom
Telephone +44 (0) 28 3836 1000
Fax +44 (0) 28 3836 1010

www.ajpower.net

SOUTH AFRICA

FGW Generators
5 Falcon Crescent
Airport City
Cape Town
South Africa
7490
Telephone +27 (0)21 386 5116

www.fgwgenerators.co.za

SWEDEN

AJ Reservkraft Sverige AB
Ryttarevägen 18A
302 62 Halmstad

Telephone +46 (0) 35 265 22 30

www.ajreservkraft.se

UAE SALES OFFICE

AJ Power Limited (DMCC Branch)
37th Floor,
Jumeirah Business Centre 2
Jumeirah Lake Towers
Dubai, UAE
PO Box 113154

Email:dmcc@ajpower.net

SOUTH ENGLAND

Unit 21 Eventus
Sunderland Road
Northfields Industrial Estate
Market Deeping
Peterborough
PE6 8FD
Telephone +44 (0)1778 382 709

www.ajpower.net

LOCAL DISTRIBUTION PARTNER

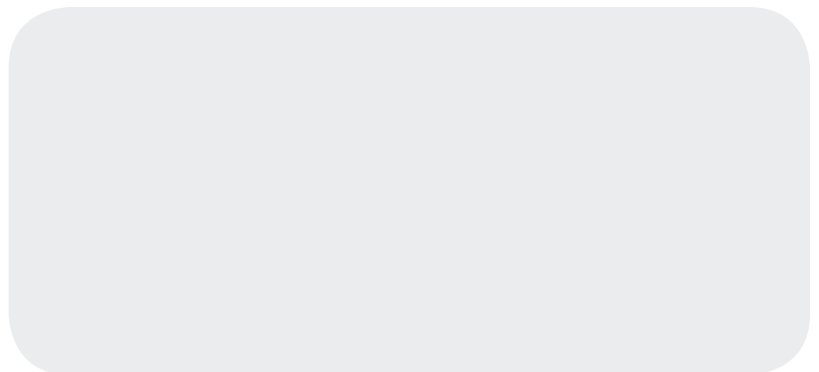

facebook.com/ajpowerltd
twitter.com/ajpower
linkedin.com/company/ajpower

Every effort has been made to ensure that the information in this publication is as accurate and current as possible. However, inaccuracies, errors or omissions may occur and details of the specifications may be changed at any time without notice.

Publication No.
© AJ Power Limited 2022